

F4010

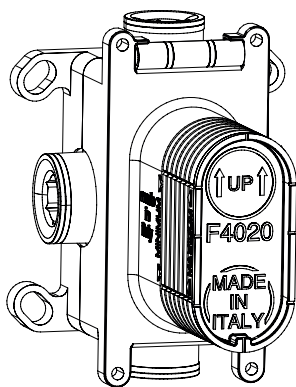

F4020

fima | CARLO FRATTINI®
r u b i n e t t e r i e

CONDIZIONI DI FUNZIONAMENTO
 OPERATING CONDITIONS
 CONDITIONS DE FONCTIONNEMENT
 CONDICIONES DE FUNCIONAMIENTO
 BETRIEBSBEDINGUNGEN

УСЛОВИЯ НОРМАЛЬНОГО ФУНКЦИОНИРОВАНИЯ

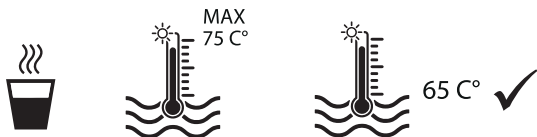

F4010

NO STOP

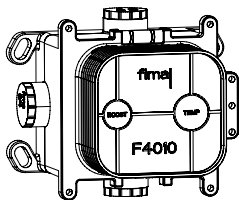

min 6l/min

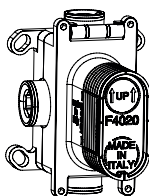

F4020

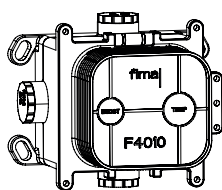

F4010

1

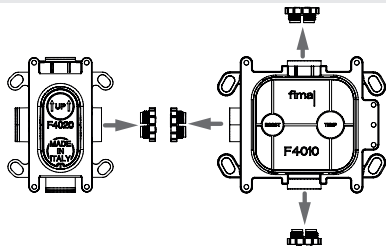

2

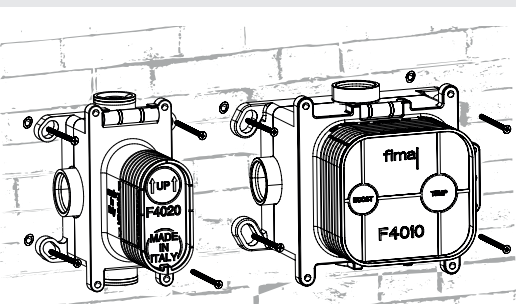

3

G 3/4



a1

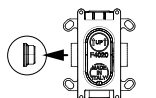

a2

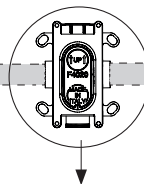
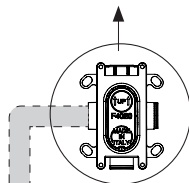
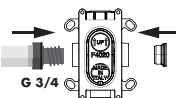

b1

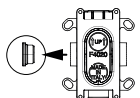

b2

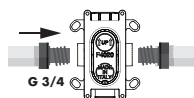

4

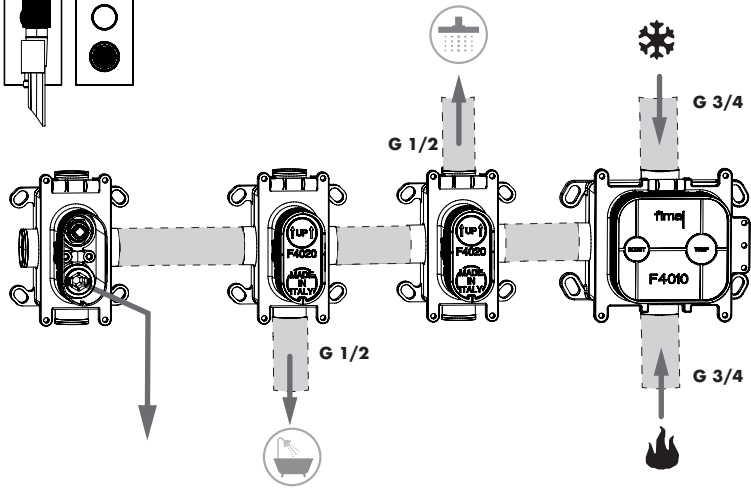
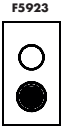
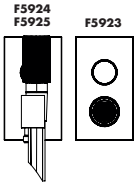
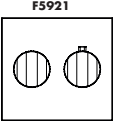
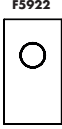
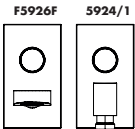

5

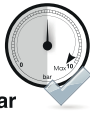
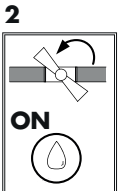
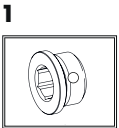
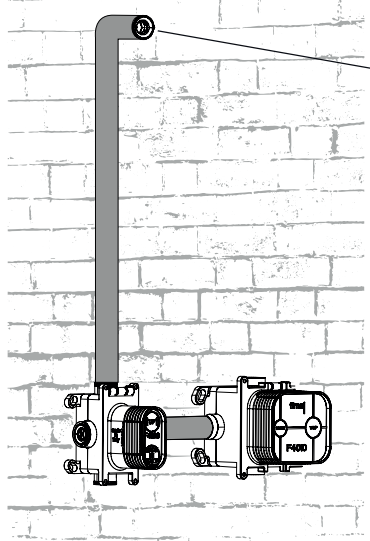

6

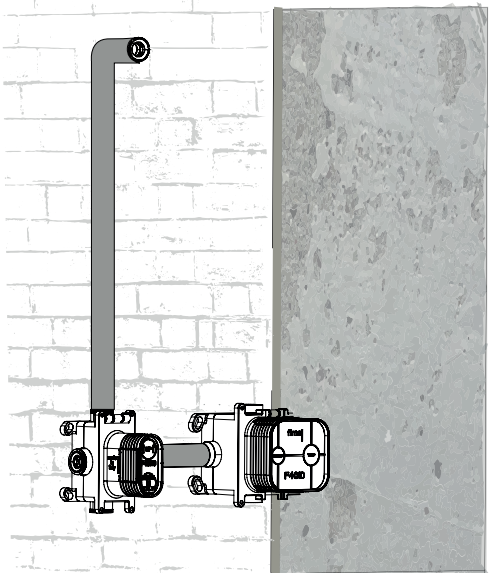

7

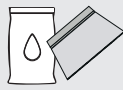

8

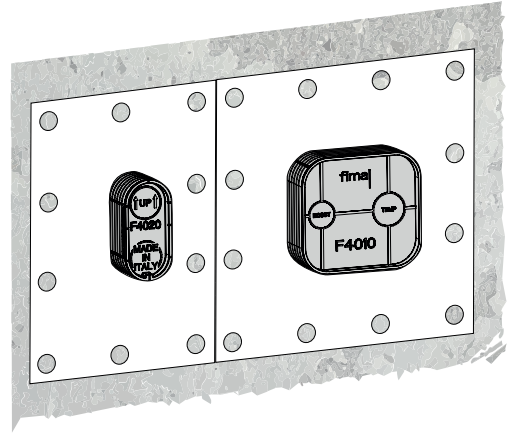
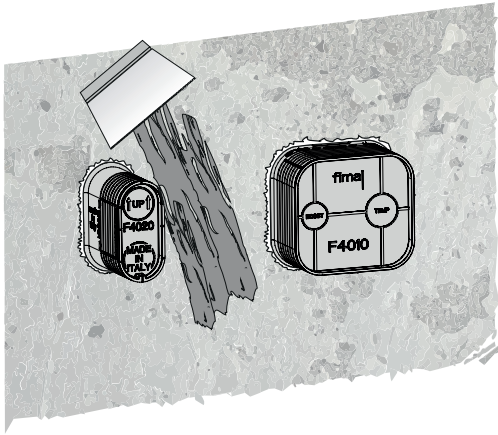

9

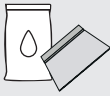

10



1

2

